

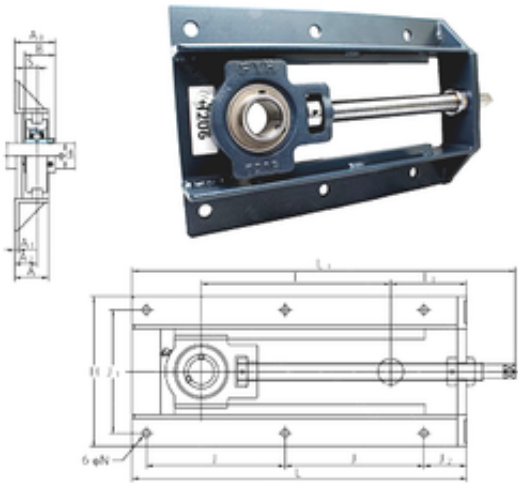

NTN Bearing Driveshaft do Brasil



UCTH210-30-300 Bearing 2D drawings and 3D CAD models

FYH UCTH210-30-300 bearing units

Bearing No. UCTH210-30-300

Bore Diameter	47,625 mm
Width	121 mm
d	47,625 mm
A0	67,6 mm
T1	121 mm
A	50 mm
A1	6 mm
B	51,6 mm
H	234 mm
J	219 mm
L	527 mm
L1	603 mm
N	15 mm
S	19 mm
T	296 mm
Bolt (G)	M12
A2	35 mm
J1	192 mm
J2	67 mm
Weight	12,6 Kg
Basic dynamic load rating (C)	35,1 kN
Basic static load rating (C0)	23,3 kN