

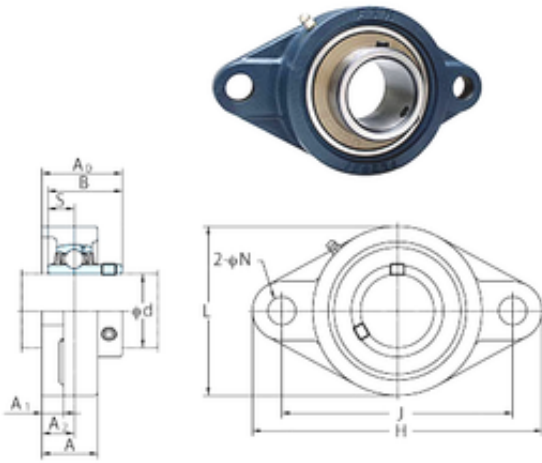

NTN Bearing Driveshaft do Brasil

FYH UCFL209-26 bearing units

Bearing No. UCFL209-26



UCFL209-26 Bearing 2D drawings and 3D CAD models

Bore Diameter	41,275 mm
d	41,275 mm
A0	52,2 mm
A	38 mm
A1	15 mm
B	49,2 mm
H	188 mm
J	148 mm
L	108 mm
N	19 mm
S	19 mm
Bolt (G)	14
Bolt (G)	M16
A2	22 mm
Weight	1,9 Kg
Basic static load rating (C0)	34,1 kN