

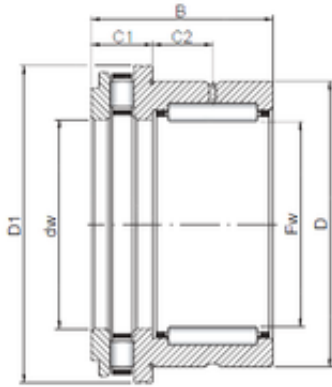

NTN Bearing Driveshaft do Brasil

35 mm x 47 mm x 30 mm 35 mm x 47 mm x 30 mm ISO NKXR 35 complex bearings



Bearing No. NKXR 35

Size	35x47x30 mm
Bore Diameter	35 mm
Outer Diameter	47 mm
Width	30 mm
d	35 mm
Fw	35 mm
D	47 mm
B	30 mm
C1	12 mm
D1	52,1 mm
C2	9 mm

NKXR 35 Bearing 2D drawings and 3D CAD models