

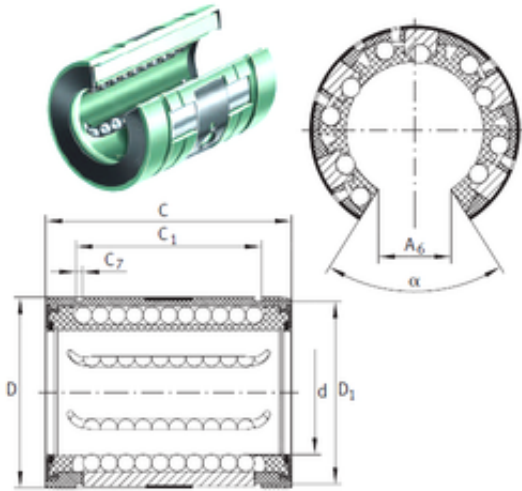

NTN Bearing Driveshaft do Brasil

INA KNO 20 B-PP linear bearings

Bearing No. KNO 20 B-PP



KNO 20 B-PP Bearing 2D drawings and 3D CAD models

Size	20x32x45 mm
Bore Diameter	20 mm
Outer Diameter	32 mm
Width	45 mm
d	20 mm
D	32 mm
C	45 mm
A6	9 mm
H9	0,9 mm
K4	3 mm
b1	2,5 mm
Angle	55 °